

LED 2030/2025

DRAWER AND PUCK LIGHT KITS



- > *CRI 90 lights are Title 24 Compliant
- > *CRI 90 lights offer more vibrant, true color rendering than lower CRI products
- > Surface mounted; easy to install; flexible universal design
- > Ideal for new or existing interior kitchen cabinets
- > Trimmable in 50 mm (2") increments
- > Peel and stick strips and wire management channels; screw mounted switch housing

- > *CRI 90 lights are Title 24 Compliant
- > *CRI 90 lights offer more vibrant, true color rendering than lower CRI products
- > Surface mounted; easy to install; flexible universal design
- > Ideal for new or existing kitchen interior cabinets or under cabinets
- > Screw mounted
- > Modular

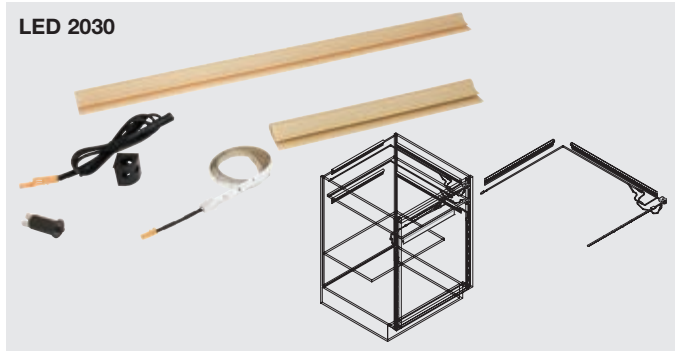

- > Driver see page 51
- > Components see page 127



Item No.	833.73.580	833.73.585
SRP	\$60.00	\$60.00
Light Color (K)	warm white	cool white
L x W x H	610 x 8 x 2.3 mm (24" x 5/16" x 3/32")	
Wattage	3.0	
LEDs	36	
Lumen	235	236
CRI	90*	
Material/Finish	Housing and Switch: Plastic, black Wire Management: Plastic, tan Light: Silicone, white	
Supplied with	Silicone strip, switch, switch housing, switch cable 50 mm (2") lead with clip, 1 - 10" and 1 - 20" wire management channel	
Note	Loox Lights and Drivers are "Suitable for use within Closet Storage Spaces"	

Item No.	833.72.251	833.72.253	833.72.252	833.72.254
SRP	\$40.00	\$40.00	\$40.00	\$40.00
Light Shape	round		square	
Light Color (K)	warm white	cool white	warm white	cool white
Ø x H	65 x 15.6 mm (2 9/16" x 5/8")			
Wattage	3.8			
Lumen	280	302	280	302
CRI	90*			
Material/Finish	Trim Ring: Plastic, silver colored Light: Plastic, frosted			
Supplied with	Puck light, trim ring, 2 m (78 3/4") cable			
Note	Loox Lights and Drivers are "Suitable for use within Closet Storage Spaces"			

LOOX LED DRIVER

CONSTANT VOLTAGE 12 V

12 V SYSTEM

THIN PROFILE

- 1 Item No. 833.74.960
 $\otimes_1 + \otimes_2 + \dots + \otimes_6 < 20 \text{ W}$
- 2 Item No. 833.74.962
 $\otimes_1 + \otimes_2 + \dots + \otimes_6 < 40 \text{ W}$
- 3 Item No. 833.74.964
 $\otimes_1 + \otimes_2 + \dots + \otimes_6 < 60 \text{ W}$
max. 42 W per light output

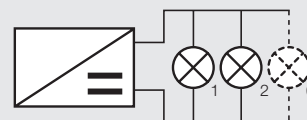

Parallel connection

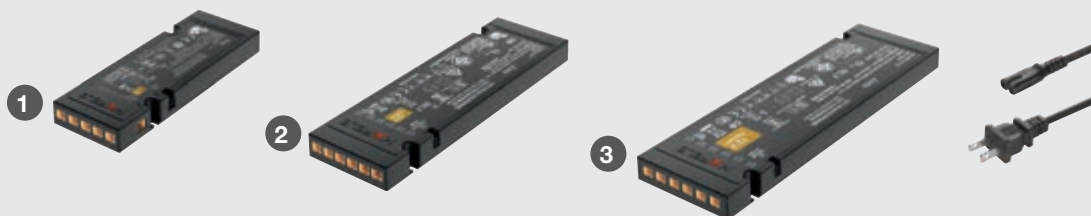

- > Suitable for all of the world's power systems
- > With an integrated port for a wide selection of switches
- > Max. 42 W per light output
- > Lead length from driver to switch: Max.: 6 m (236 1/4")

- ! > Class 2
- > Efficiency Level VI
- > Degree of protection : IP20
- > Loos drivers cannot be controlled by a dimmer wall switch

Item No.	833.74.960 1	833.74.962 2	833.74.964 3
SRP	\$36.00	\$60.00	\$80.00
L x W	140 x 50 x 16 (5 1/2" x 2" x 5/8")	190 x 60 x 16 (7 1/2" x 2 3/8" x 5/8")	230 x 70 x 16 (9 1/16" x 2 3/4" x 5/8")
Wattage	0 – 20	0 – 40	0 – 60
Standby Power Consumption Wattage	<0.1	<0.1	<0.2
Input voltage	100 – 240 V~; 50 – 60 Hz		
Output voltage	12 V DC		
Output current	1.67 A	3.33 A	5.0 A
Number of slots	6 for lights, 1 for switch, 1 for power cord		
Material/Finish	Plastic, black		
Supplied with	Mounting accessories, US power cord		
Note	Loos Lights and Drivers are "Suitable for use within Closet Storage Spaces"		

- ➔ > Switches see pages 113 - 116
- > Extension leads see page 127

- + Power cord with 90° plug
2 m (78 3/4")
> Item No. 833.89.017 **SRP \$5.00**
- 90° Plug adapter
> Item No. 833.89.018 **SRP \$7.00**

Country-specific 2 m (78 3/4") primary leads								3 m (118")
Item No.	833.89.000	833.89.001	833.89.002	833.89.003	833.89.016	833.89.005	833.89.050	833.89.008
SRP	\$10.00	\$4.00	\$4.00	\$4.00	\$4.00	\$4.00	\$4.00	\$6.00
Plug design								
Designation	UK	AU	EU	US	JP	CN	US	US
Voltage (V)	250	250	250	120	100	250	120	120

LED DRIVER

CONSTANT VOLTAGE PLUG-IN DRIVER

12 V SYSTEM

-  > Degree of protection: IP20
- > 4 m (157 1/2") lead
- > Class 2



Item No.	833.74.934	833.74.936	833.74.938
SRP	\$12.00	\$20.00	\$30.00
L x W x H	61 x 37 x 43 (2 3/8" x 1 1/2" x 1 11/16")	78 x 46 x 54 (3 1/16" x 1 13/16" x 2 1/8")	84 x 50 x 58 (3 5/16" x 2" x 2 5/16")
Stand-by Power Consumption	0.3 W		
Input voltage	100-240 V; 50-60 Hz		
Output voltage	12 VDC		
Output current	6	15	27
Degree of protection	IP 20		
Number of slots	1 socket for lead		
Material/Finish	Plastic, black		

Note
Loox Lights and Drivers are "Suitable for use within Closet Storage Spaces"



Secondary lead 12 V, Plastic, black with 2 connections

- > 4 m (157 1/2") Item No. 833.74.749 **SRP \$8.00**
- > 2 m (78 3/4") Item No. 833.74.791 **SRP \$8.00**

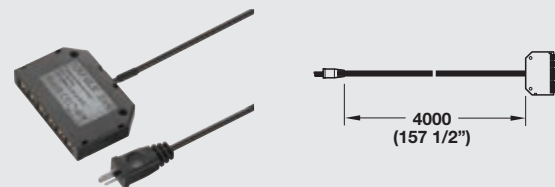

Secondary lead 12 V, Plastic, black with 6-way distributor, 4 m (157 1/2")

- > Item No. 833.74.748 **SRP \$12.00**

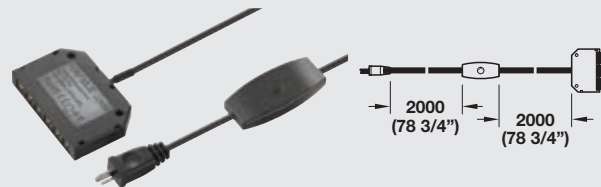

Secondary lead 12 V, Plastic, black with dimmer and 6-way distributor

- > Item No. 833.74.709 **SRP \$30.00**

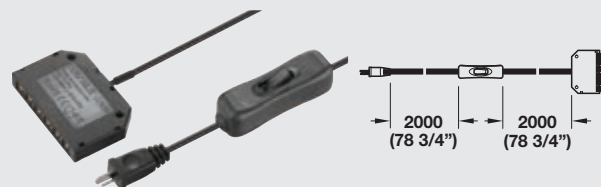

Secondary lead 12 V, Plastic, black with rocker switch and 6-way distributor

- > Item No. 833.74.746 **SRP \$24.00**